

Planta Geral Passagens Vivas
Escala 1:2000

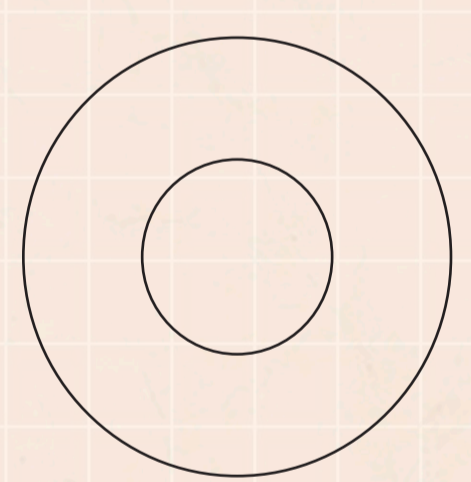

Plus More

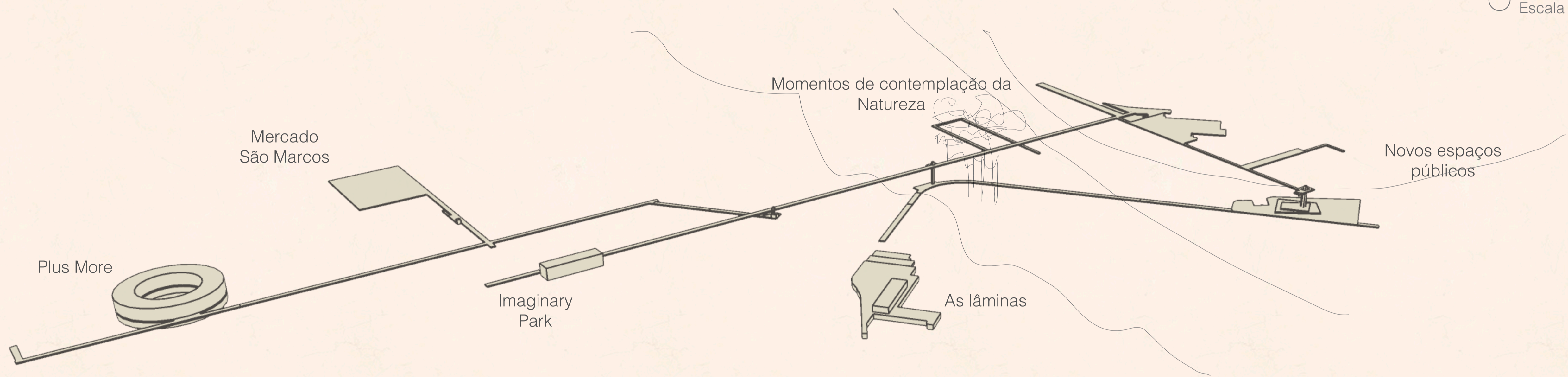
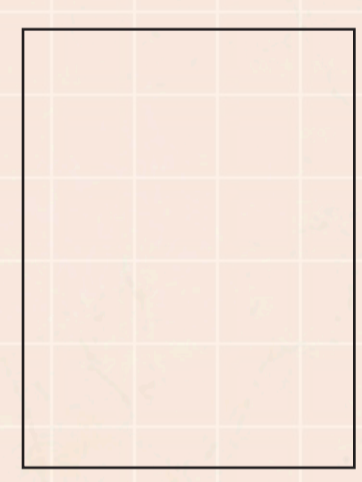

Mercado São Marcos

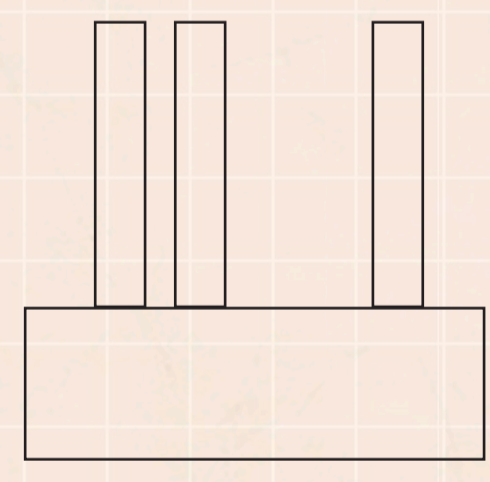

Imaginary Park

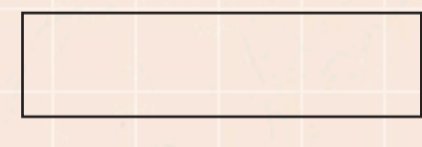

As lâminas

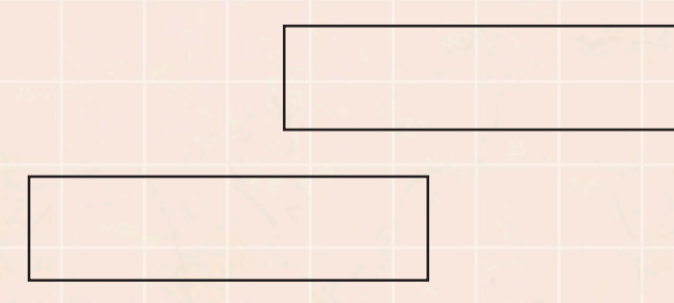

Novos edifícios residenciais

A incorporação de elementos que alimentassem a coesão espacial e construíssem um eixo polarizador de novos usos...

... que permita desenvolver um acesso interativo, capaz de inovar e atrair quem vive e que tem curiosidade de descobrir estes novos lugares



Integração nas manchas arbóreas



Novos espaços públicos



Momentos de contemplação da Natureza



Transições interativas pedonais

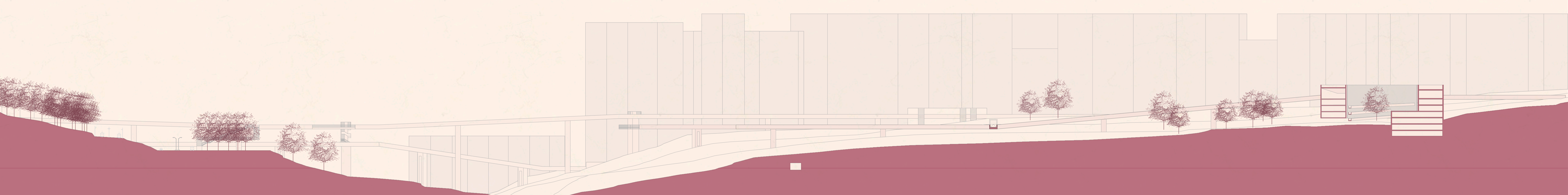

Perfil Geral Passagens Vivas
Escala 1:1000

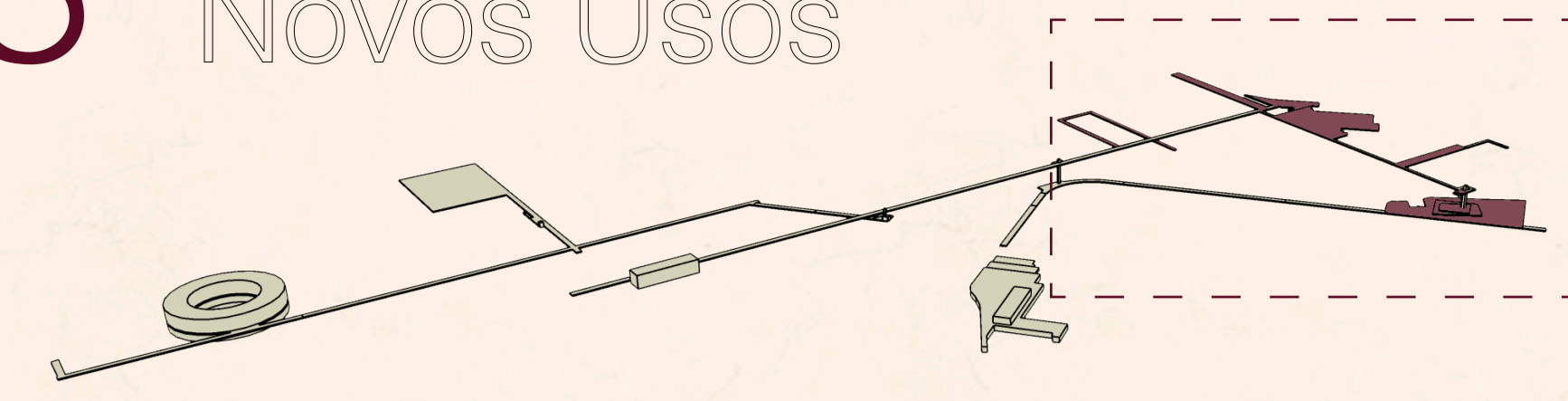

1. 2Play

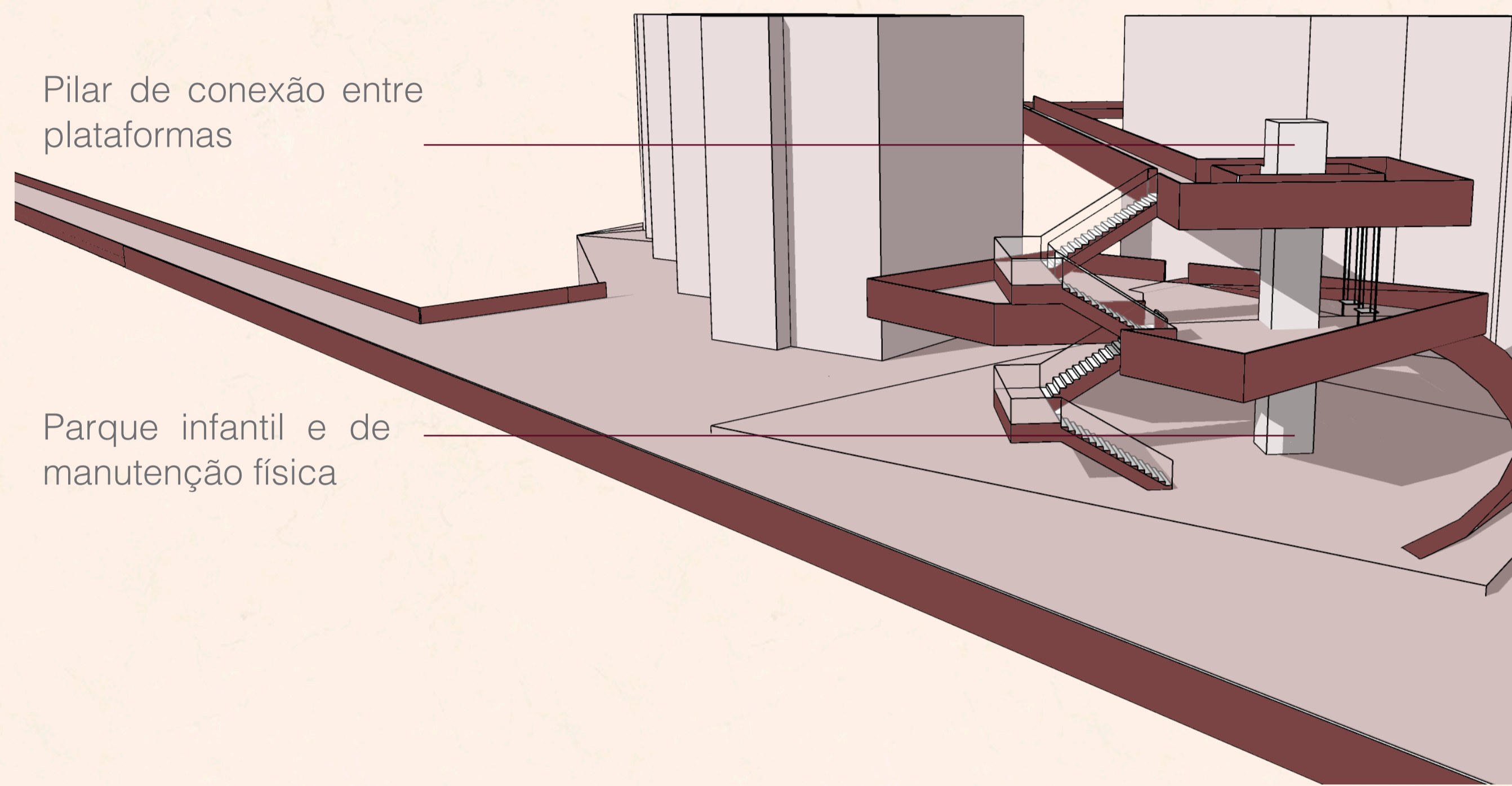

2. Car space

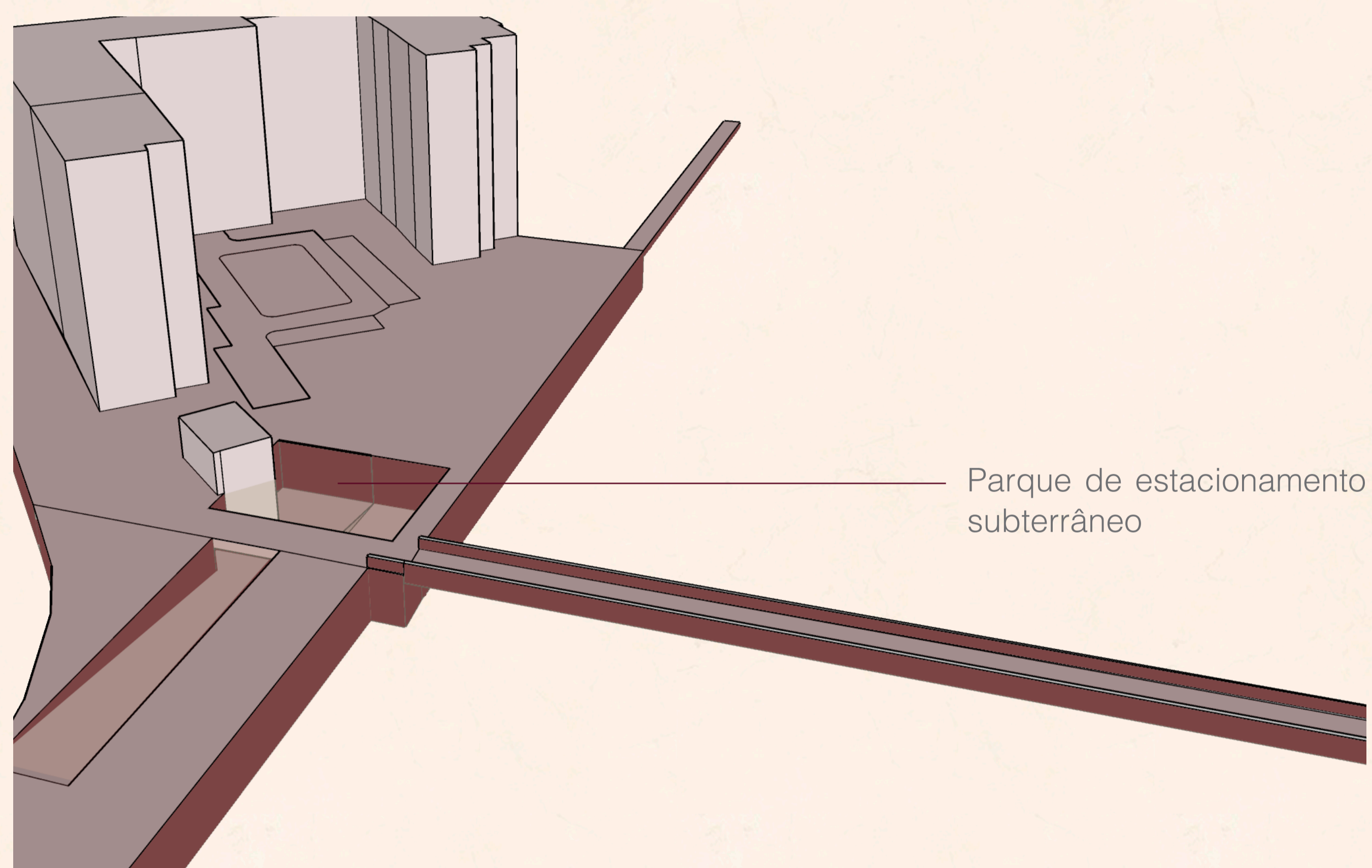

3. Mais que um ponto de espera

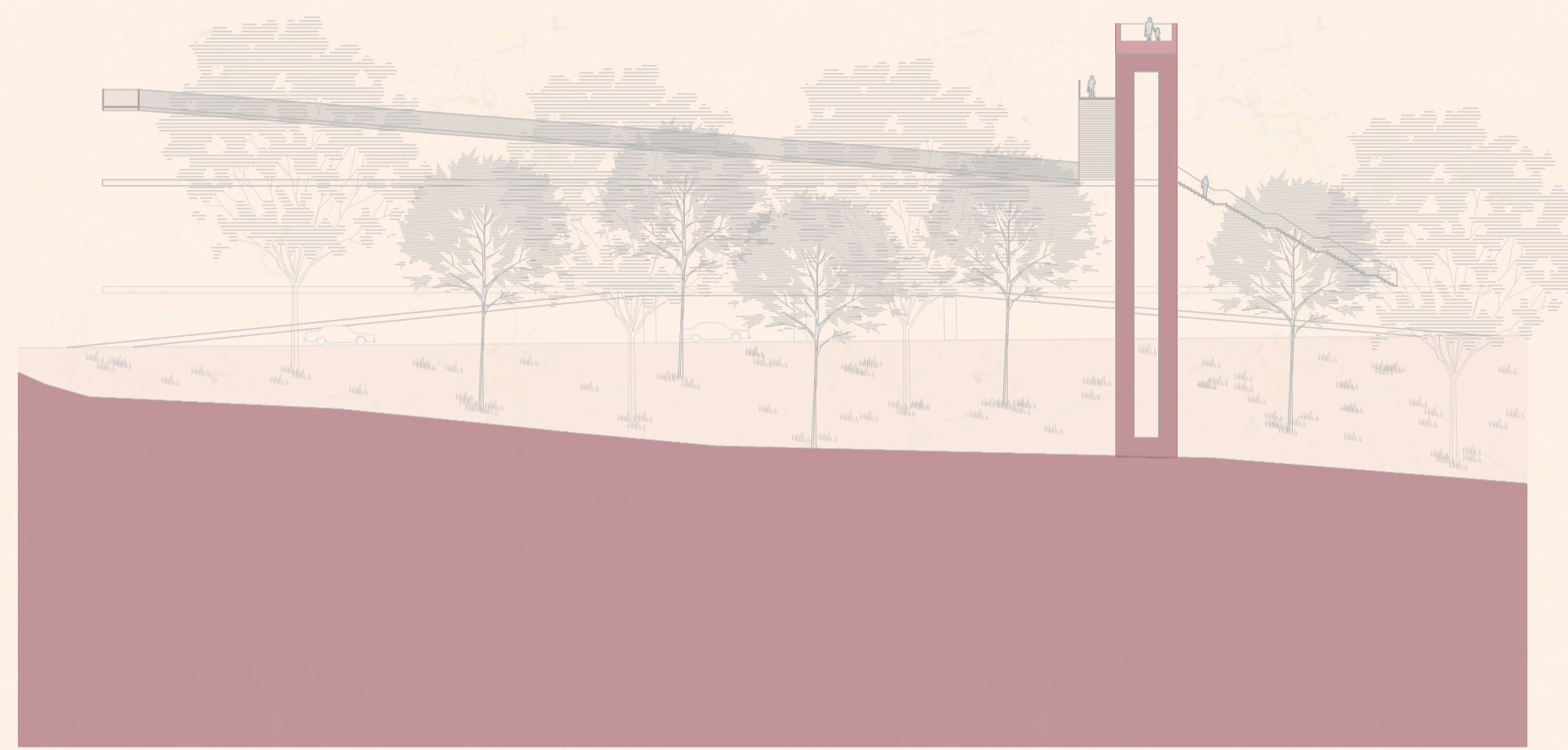
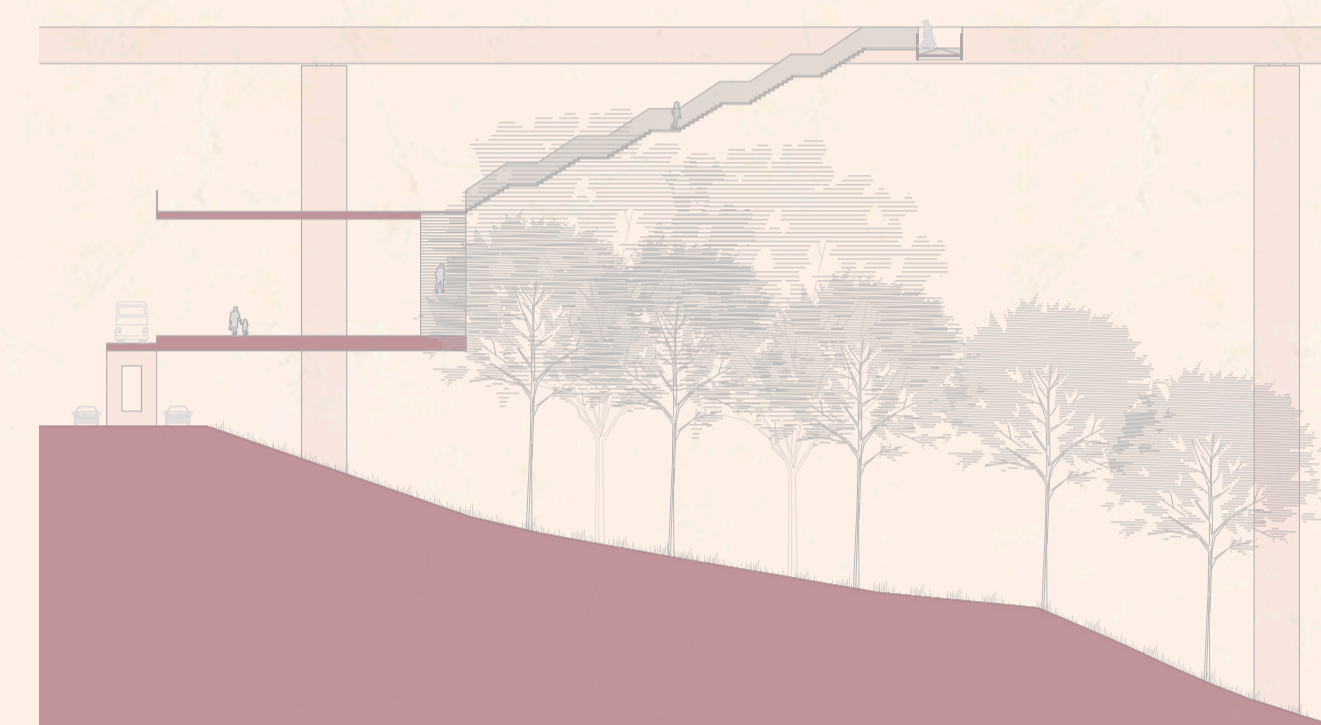
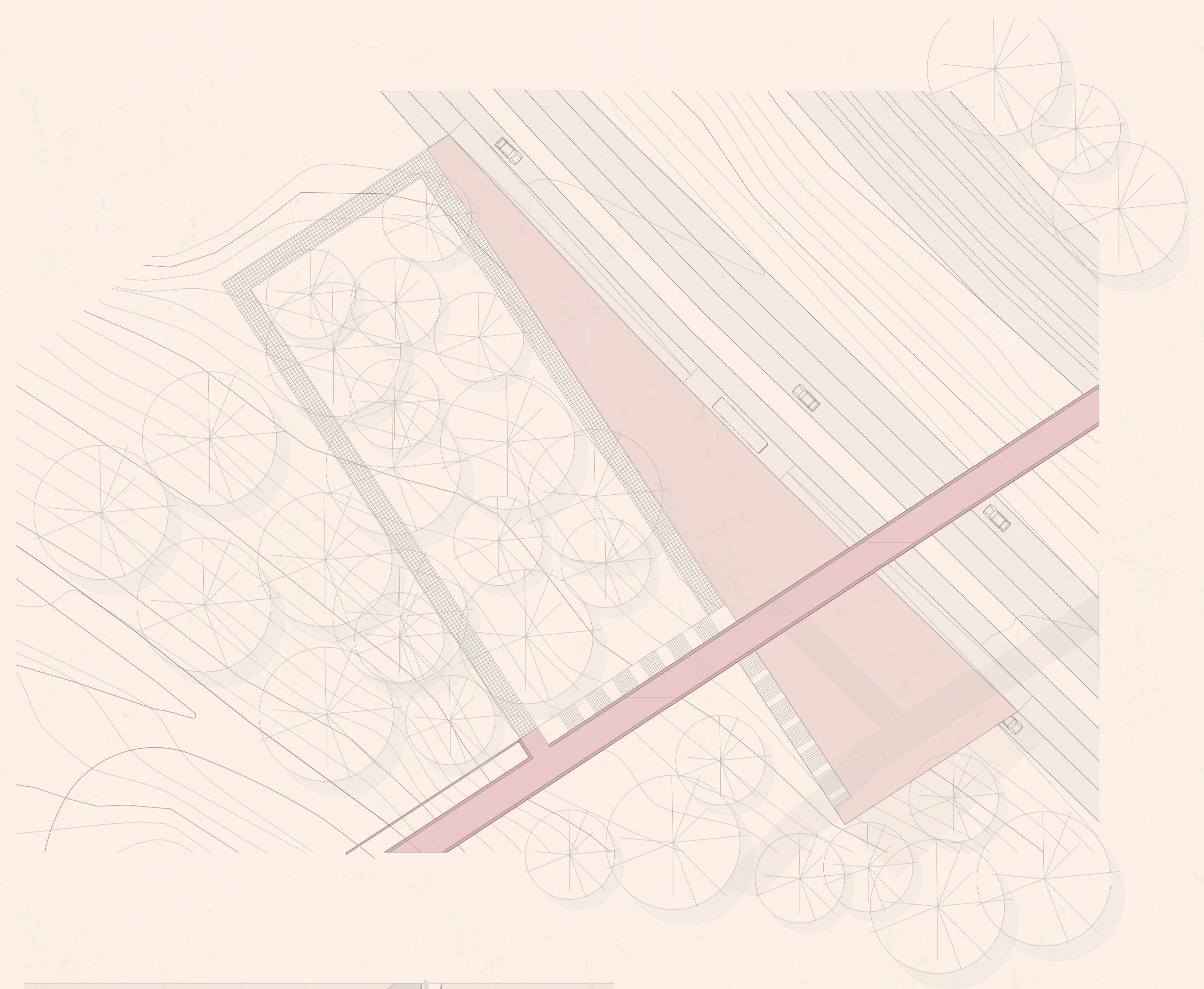

Planta e Cortes ponto 3
Escala 1:500



4. Two different Skins

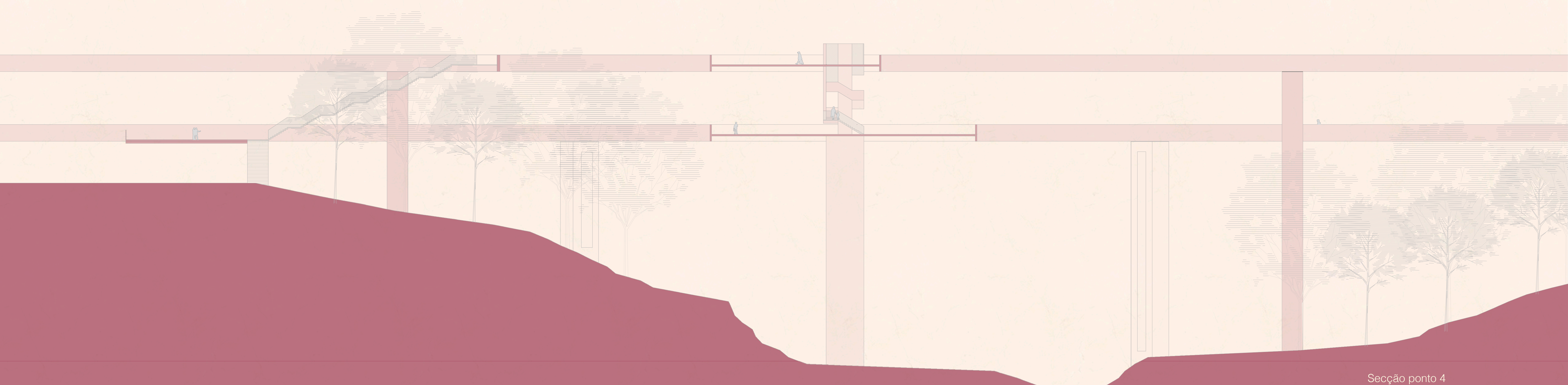

Secção ponto 4
Escala 1:250

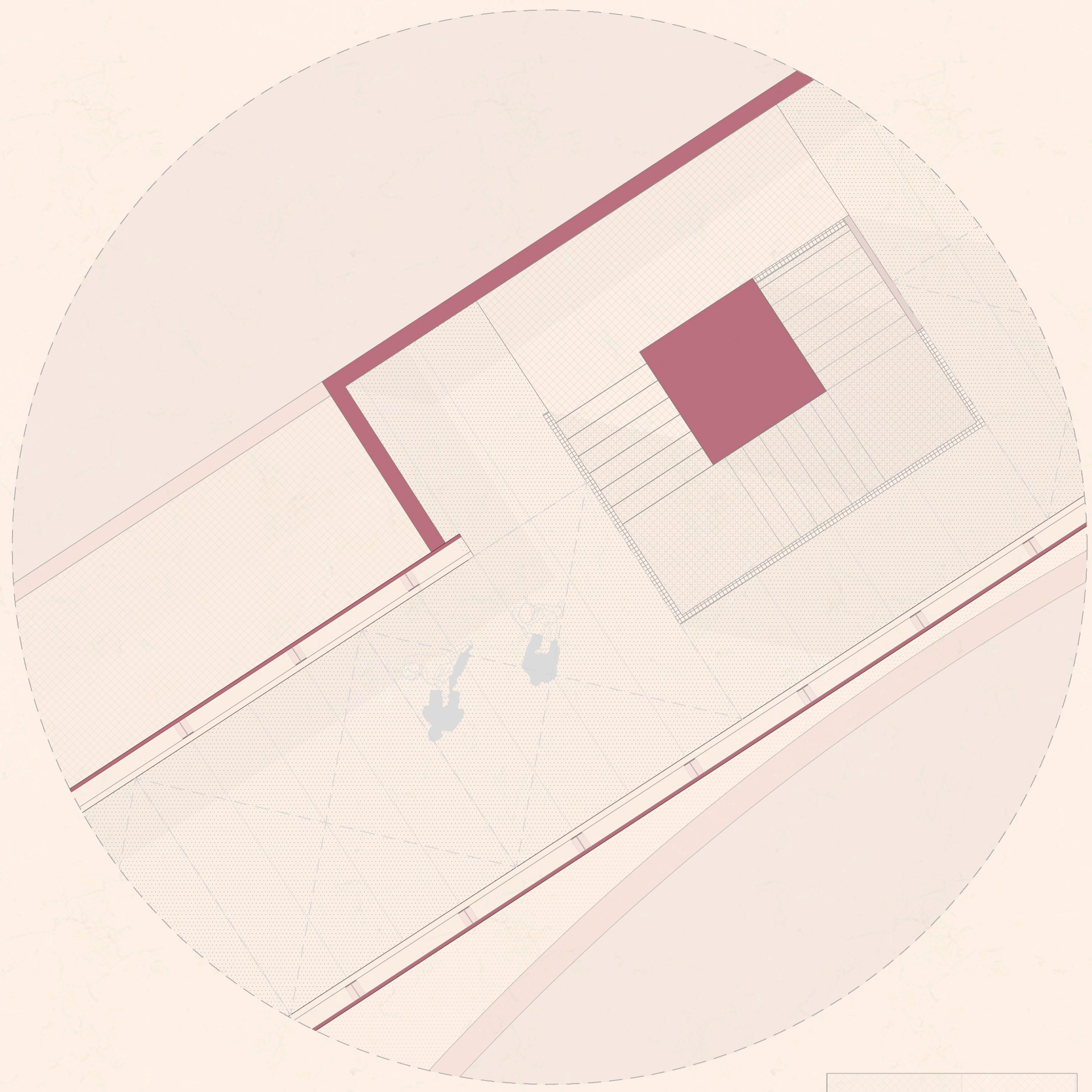
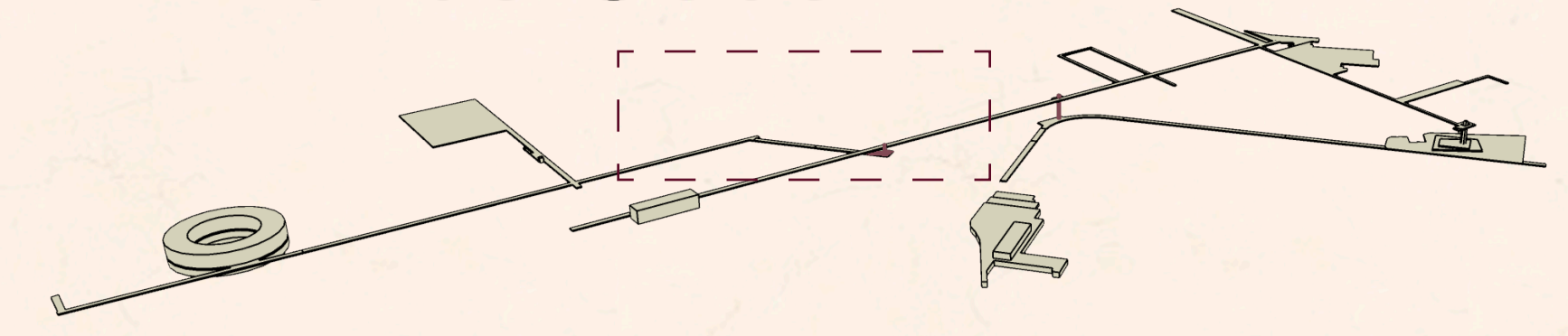

A fusão entre a preamibilidade da Rede e a dureza do Betão

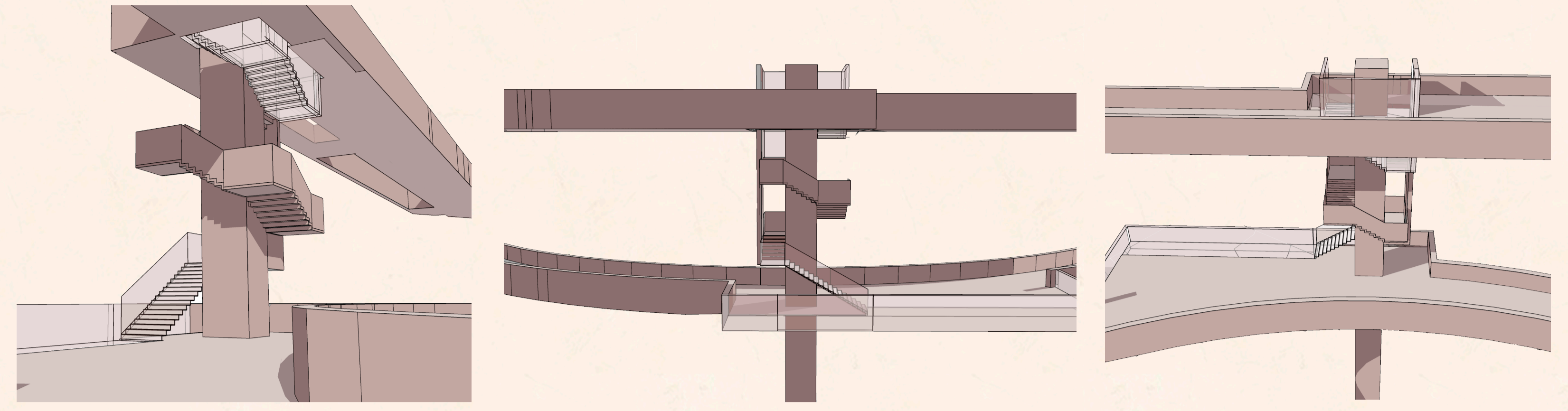

5. All Connect

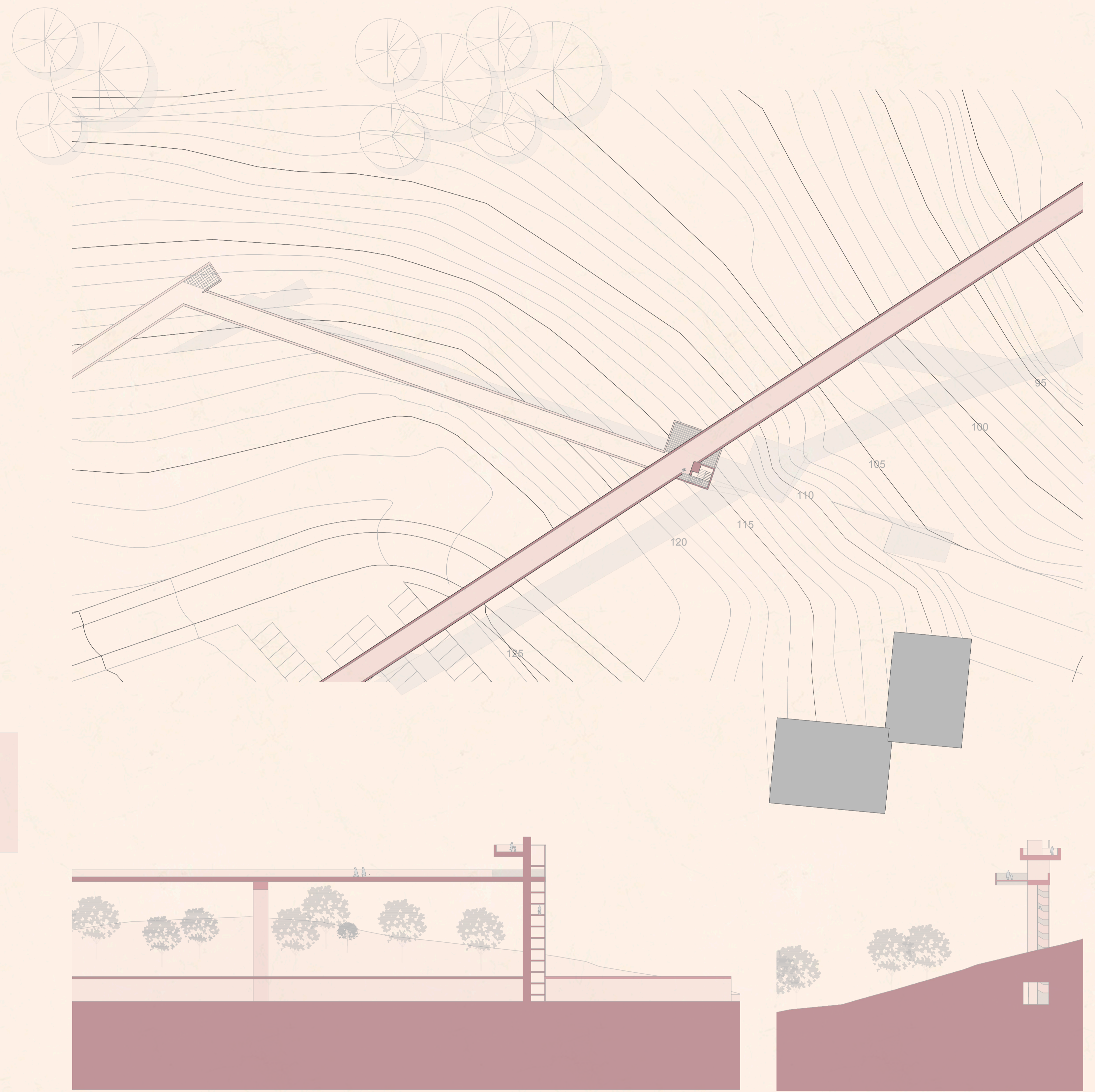

Planta e cortes ponto 5
Escala 1:500

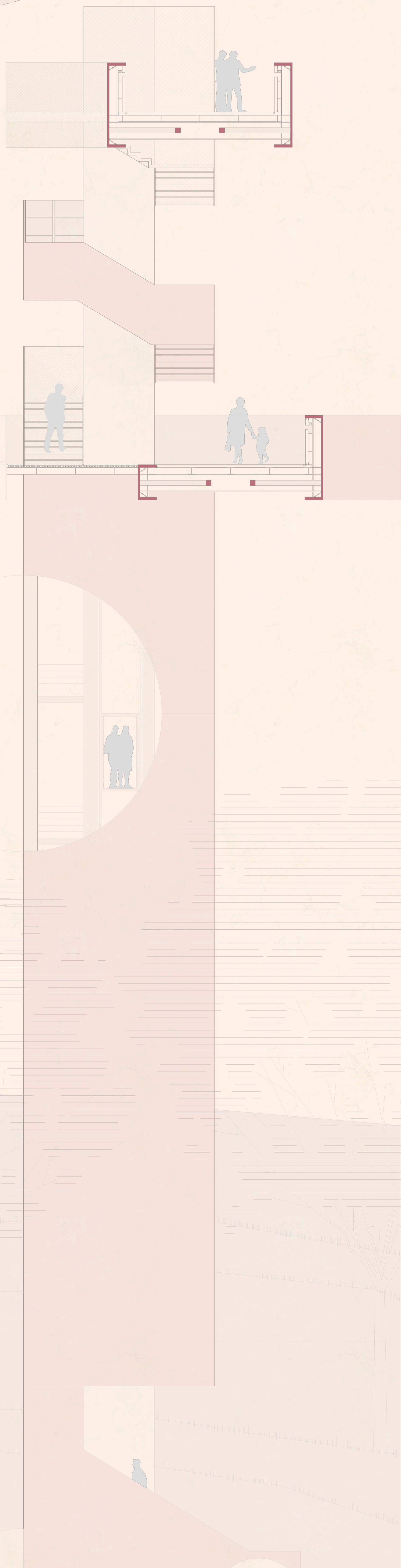

A conexão entre Níveis através do mesmo Pilar

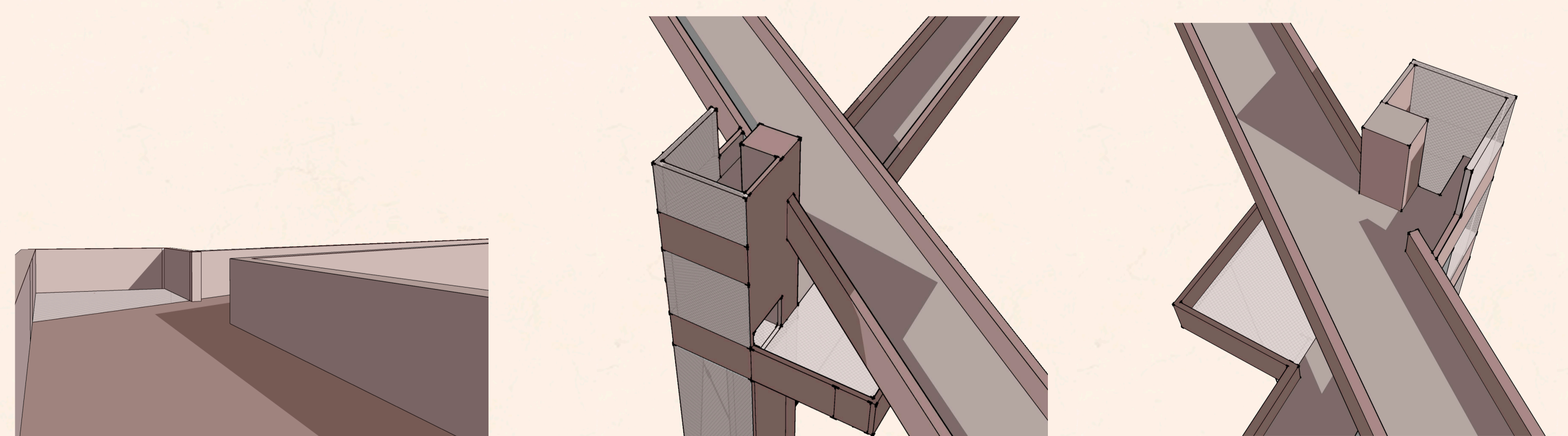

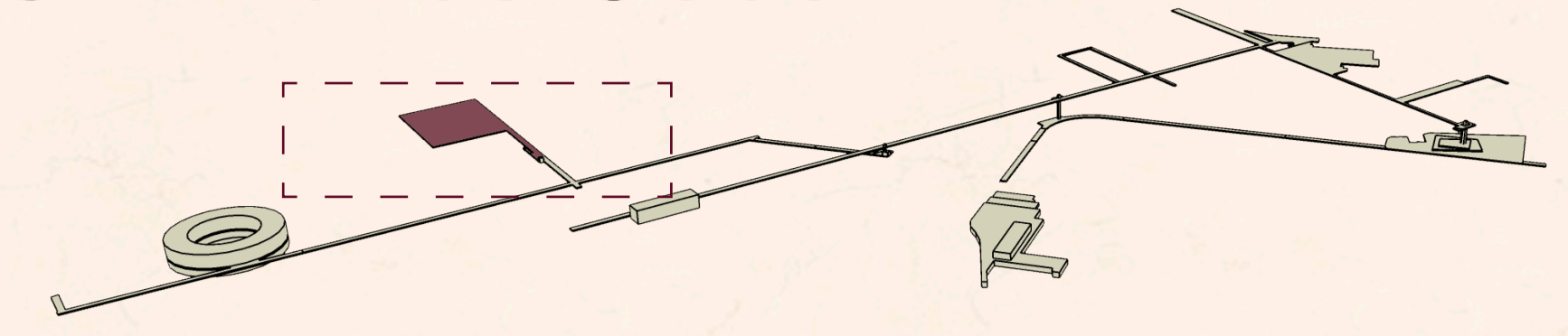

6 e 7. A Rede
O Mercado de São Marcos

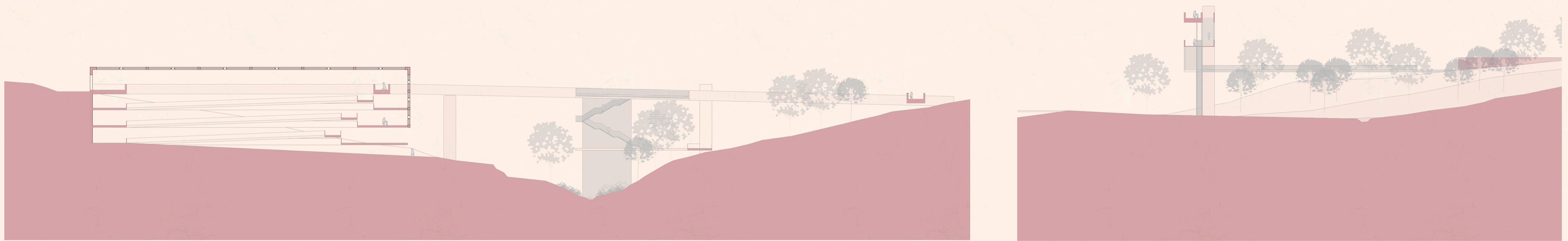
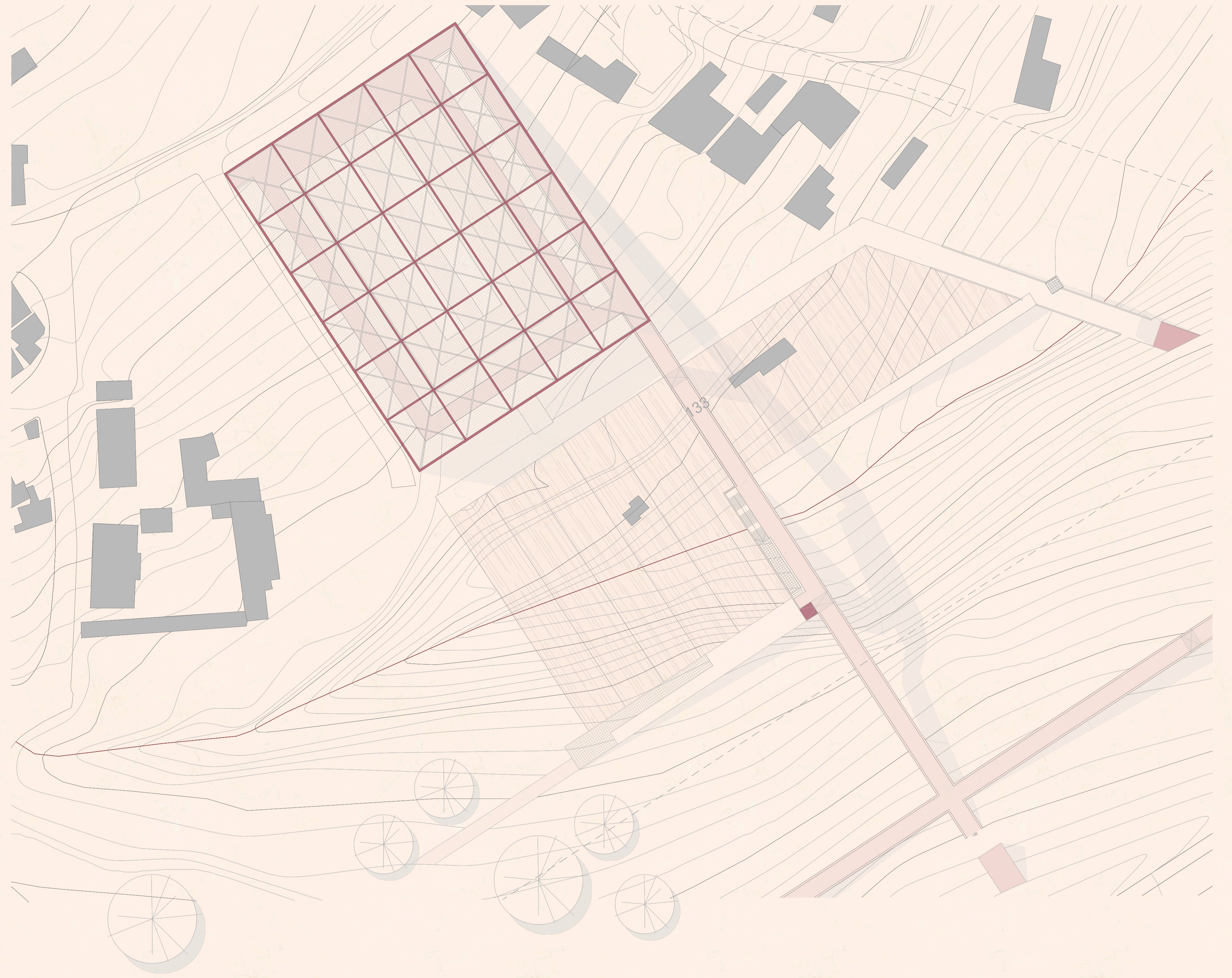
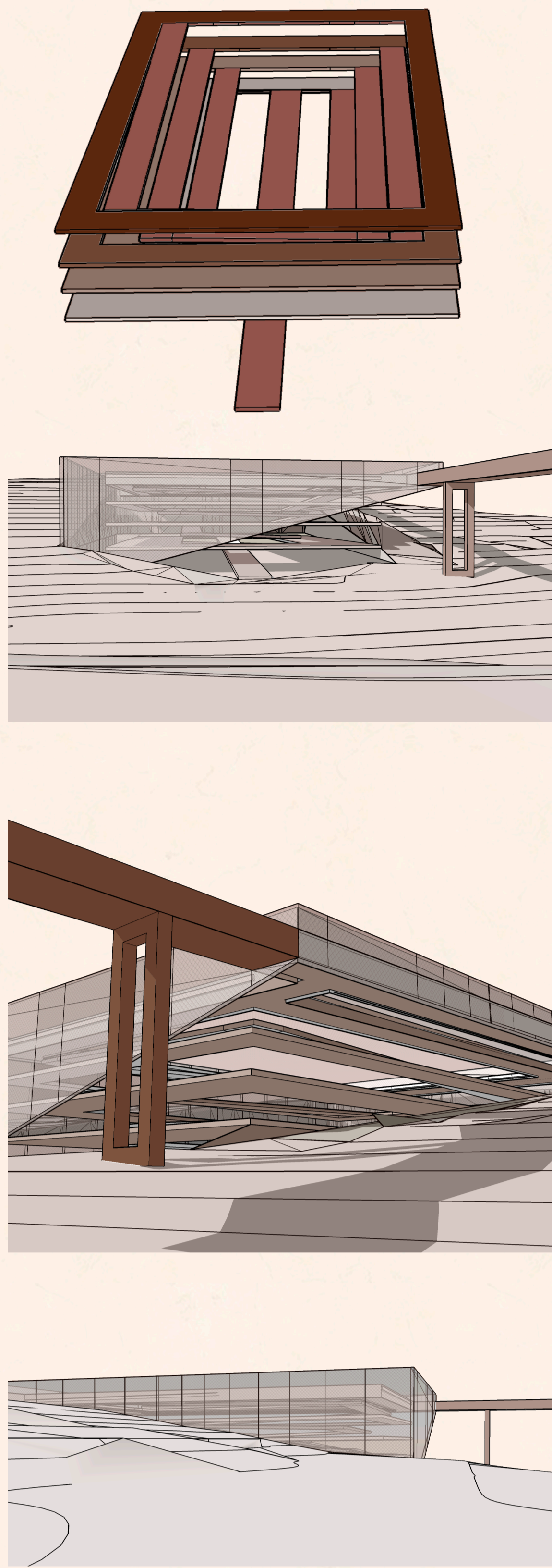

Planta e Cortes ponto 6 e 7
Escala 1:500

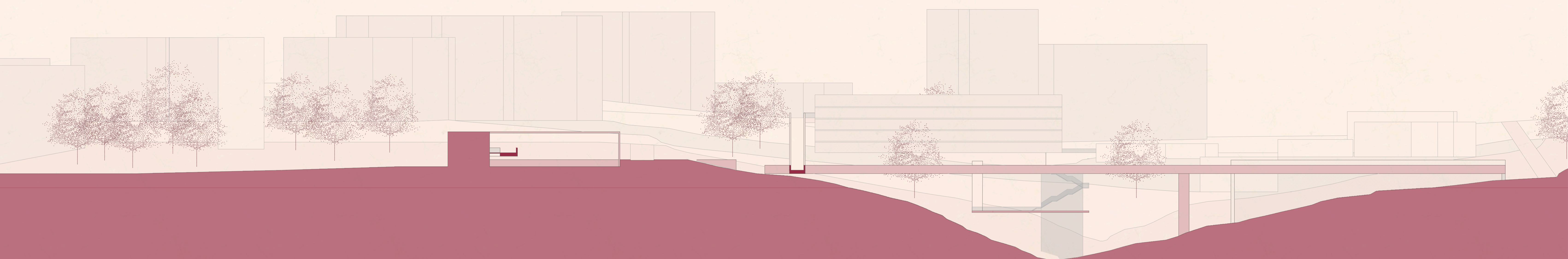
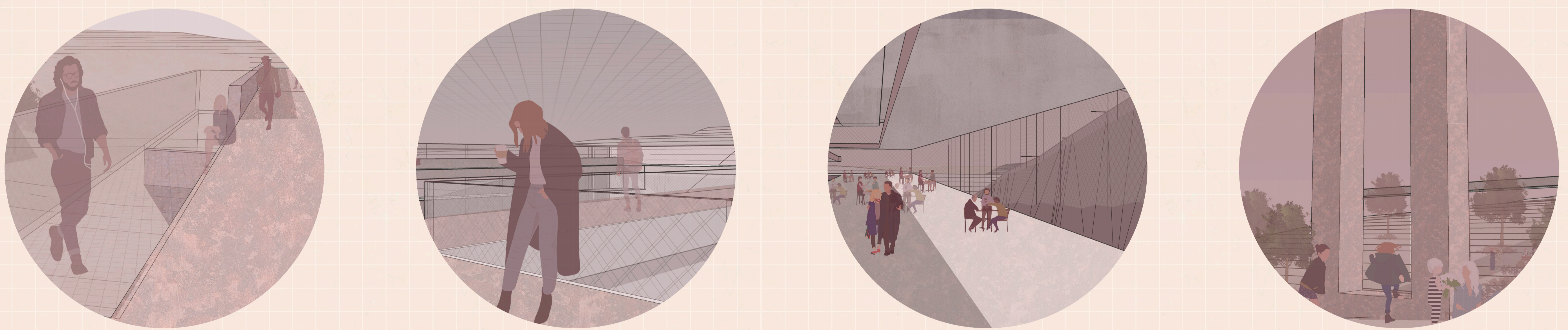

Perfil Geral Passagens Vividas
Escala 1:1000

11. Imaginary Park

10. As Lâminas

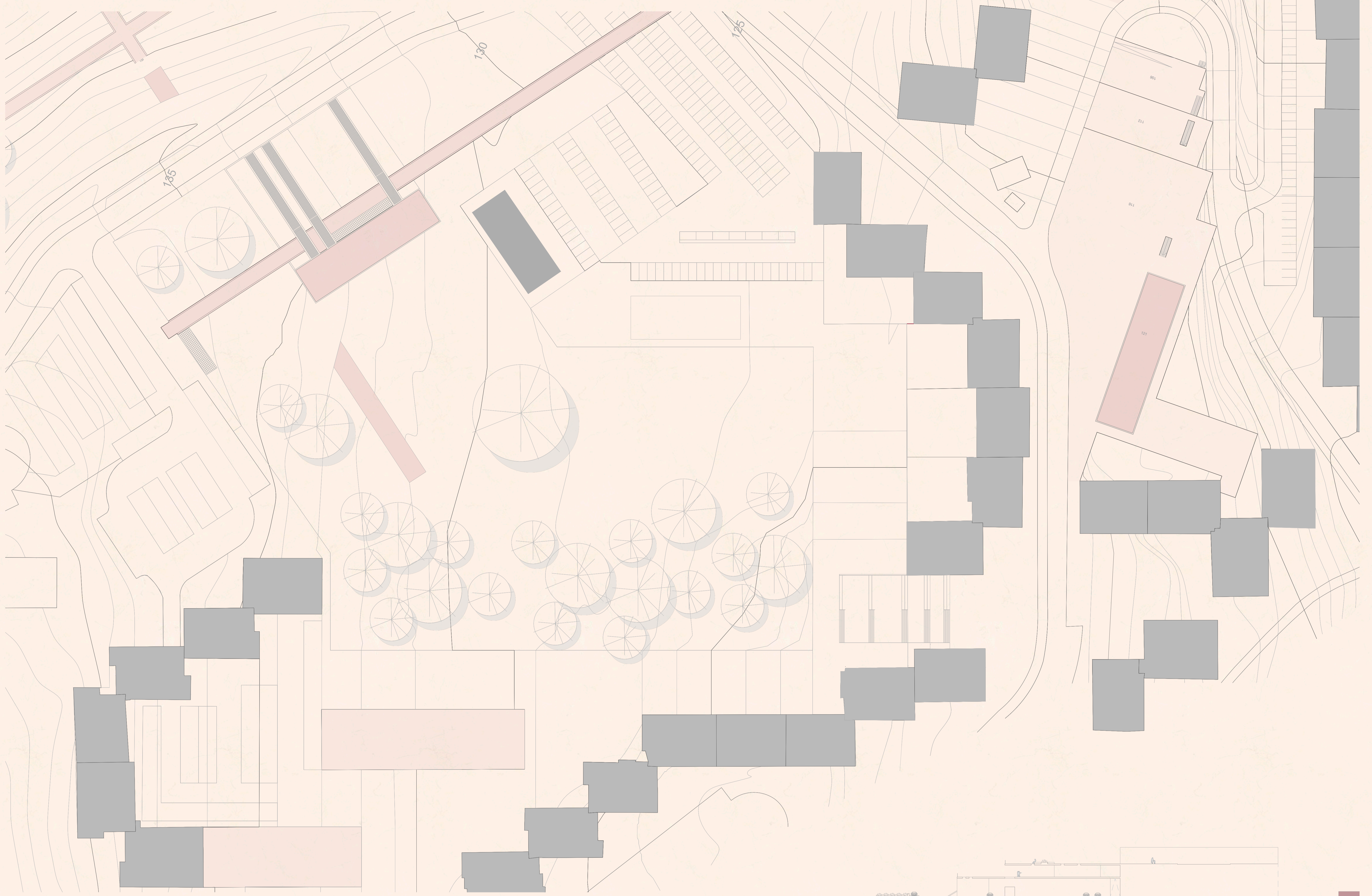
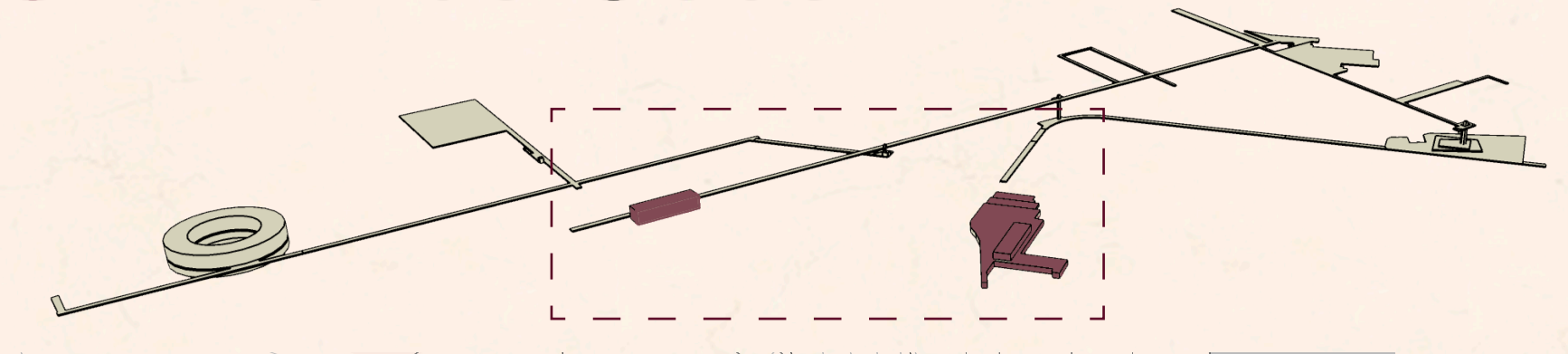

Planta e Cortes ponto 10 e 11
Escala 1:500

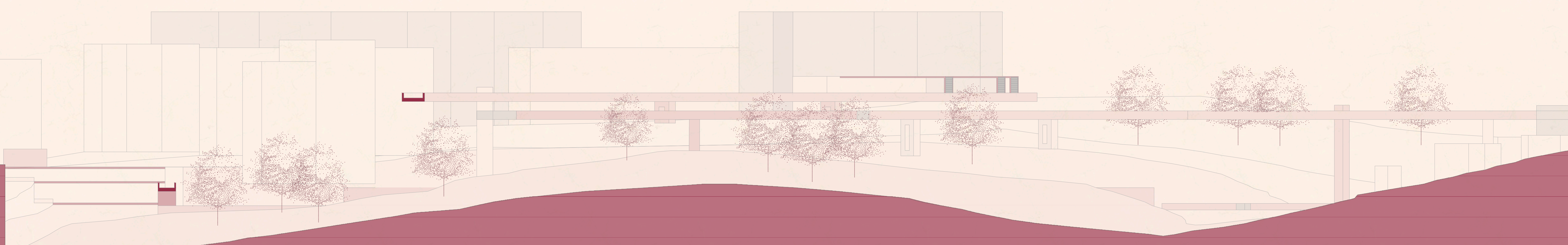
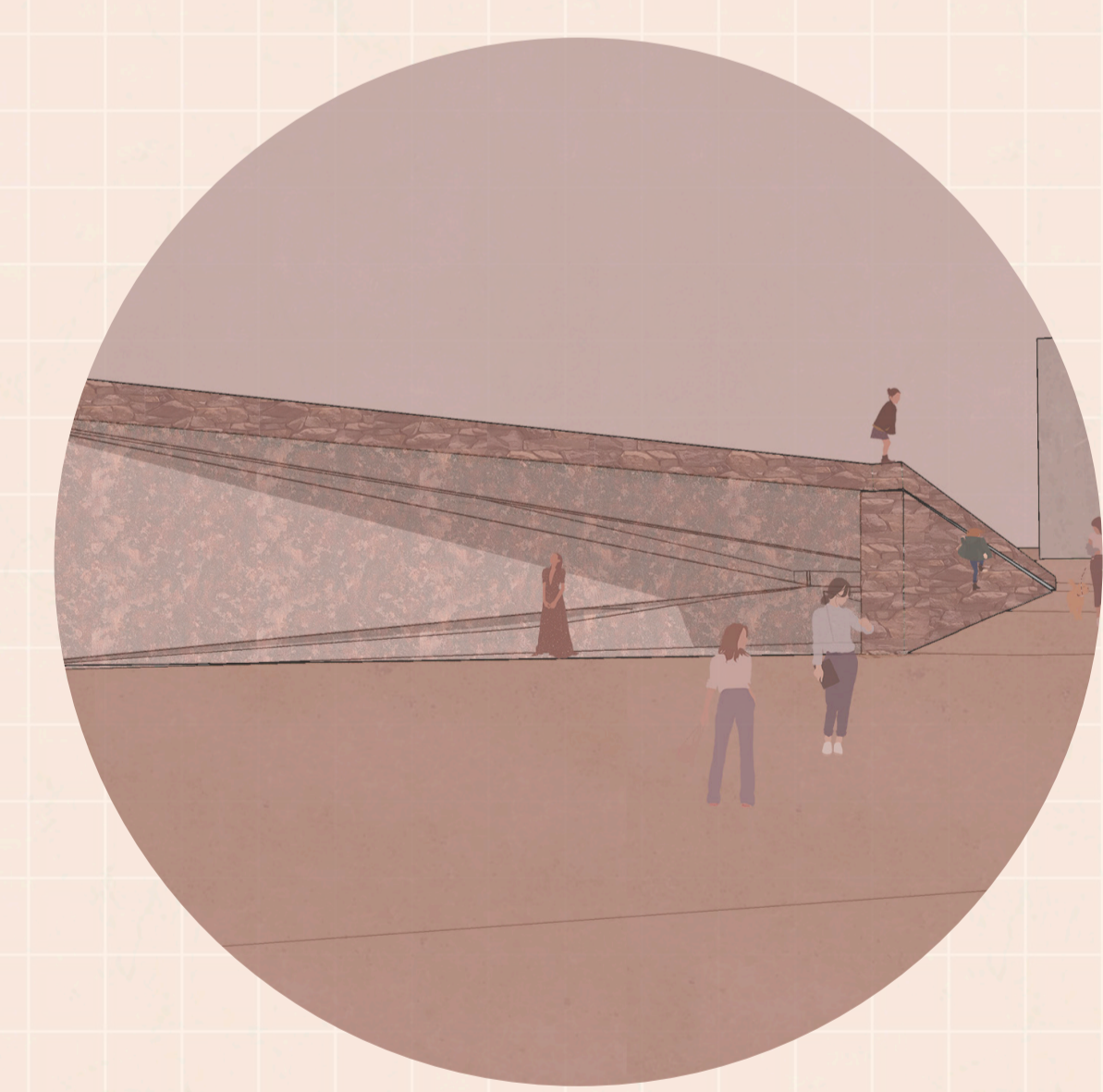
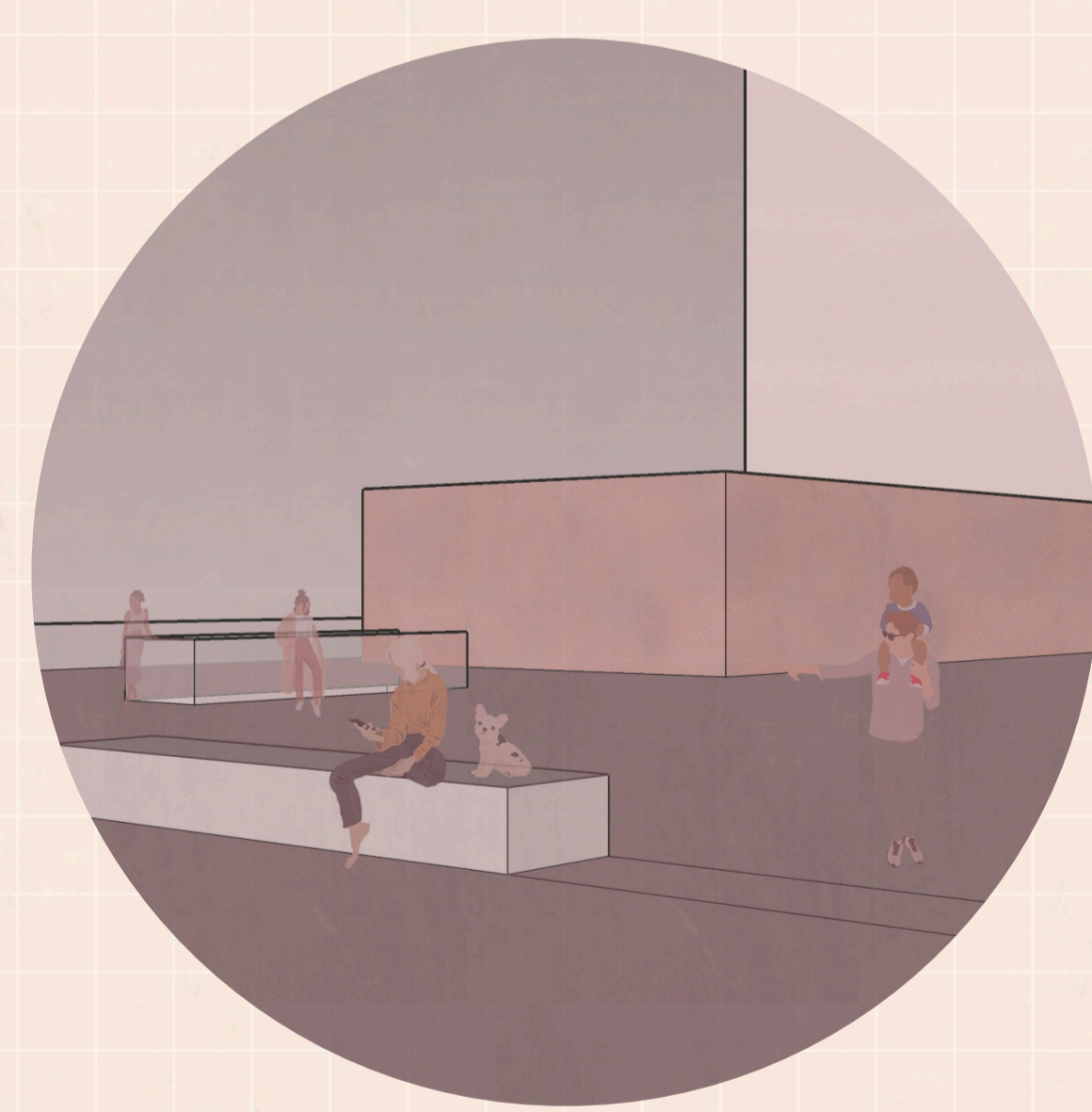
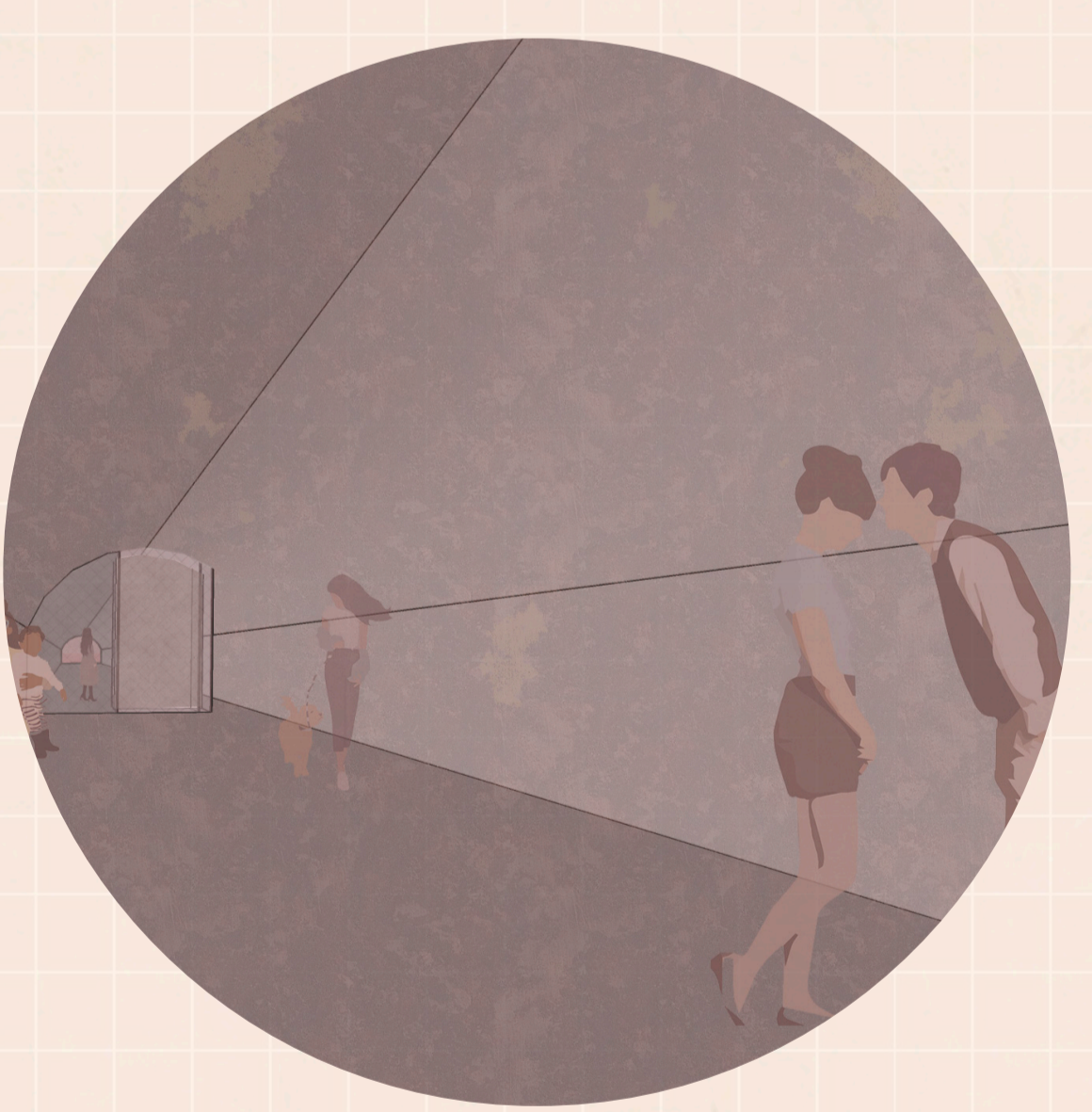

Perfil Geral Passagens Vividas
Escala 1:1000

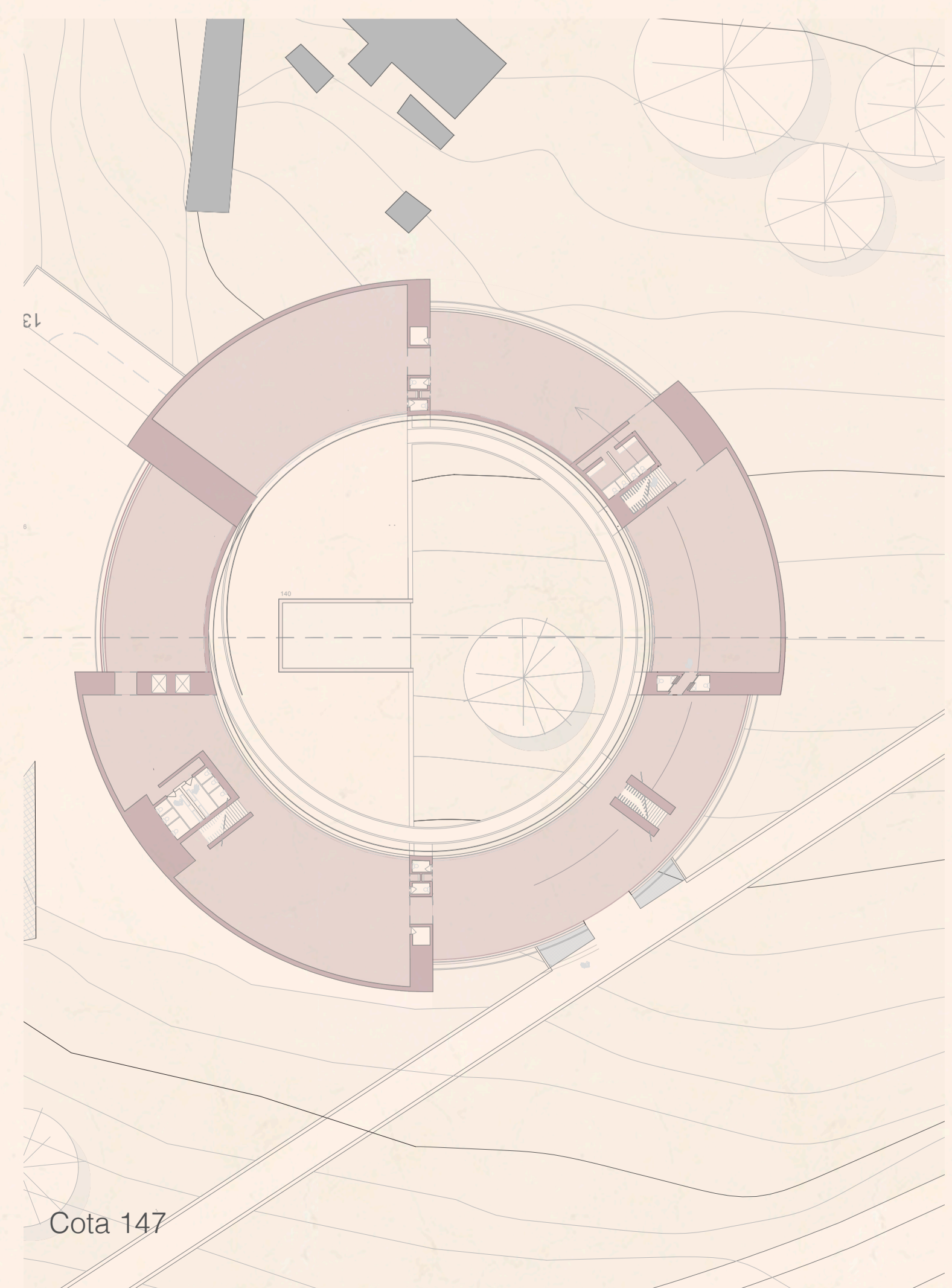
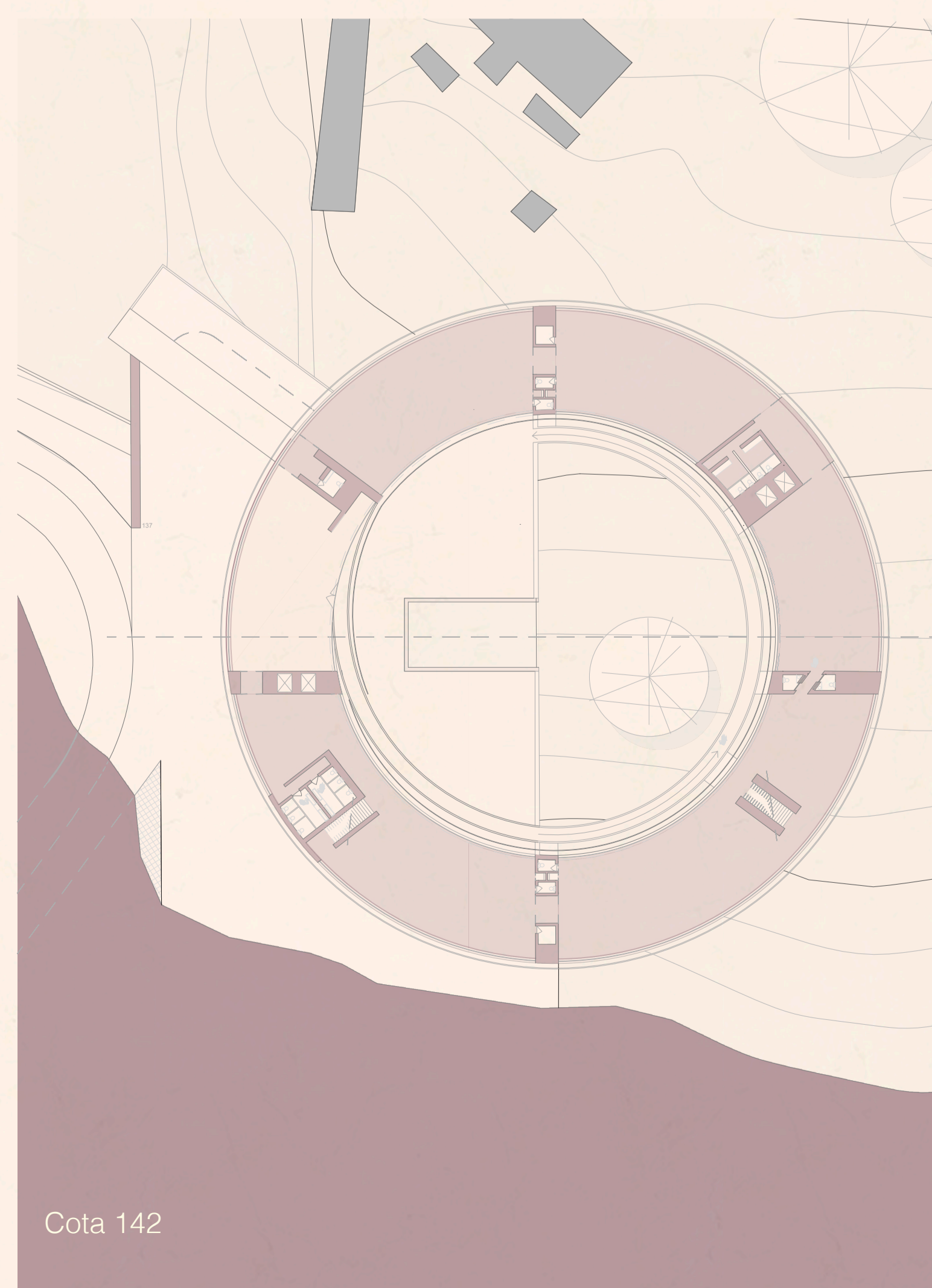
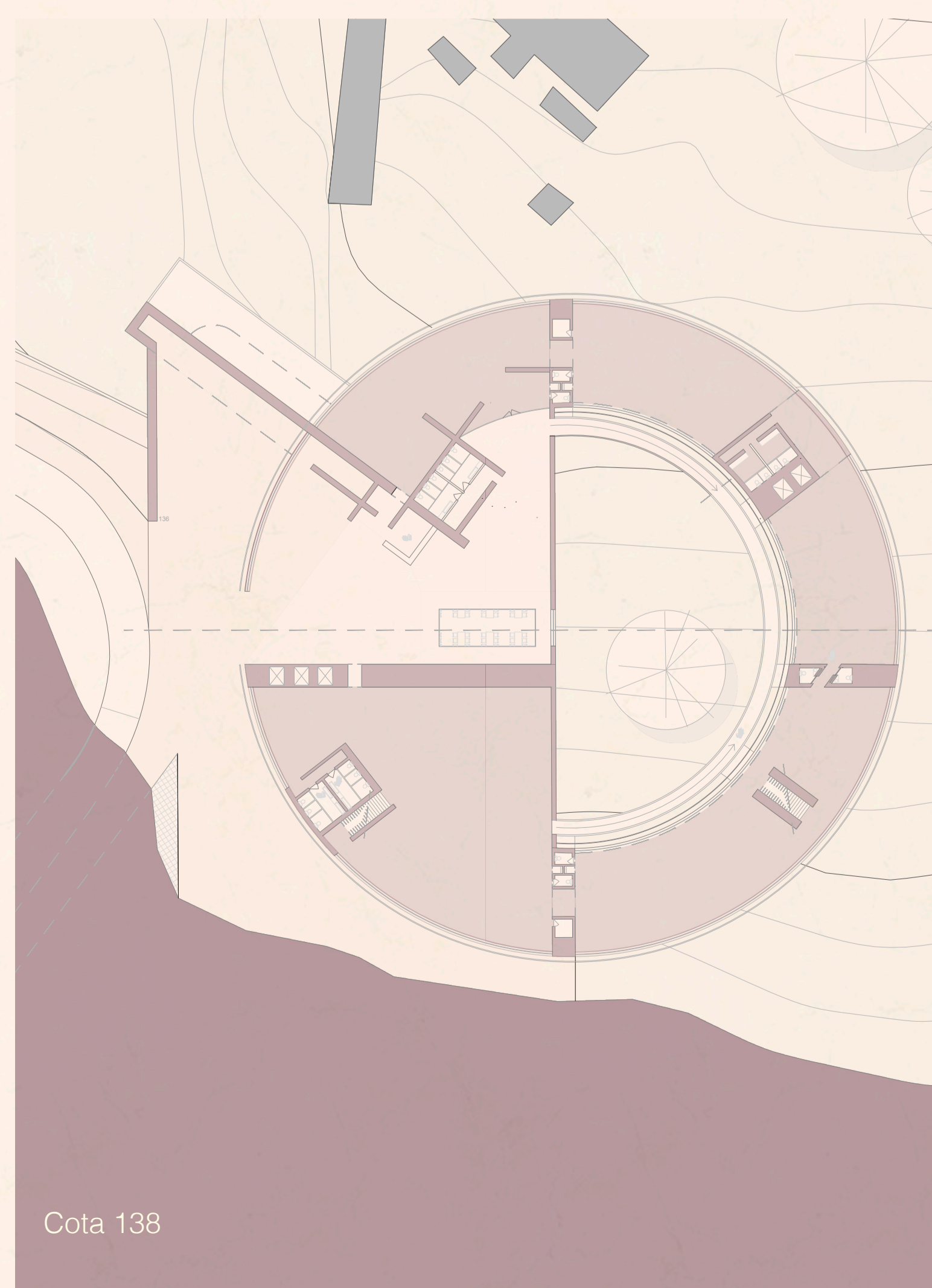
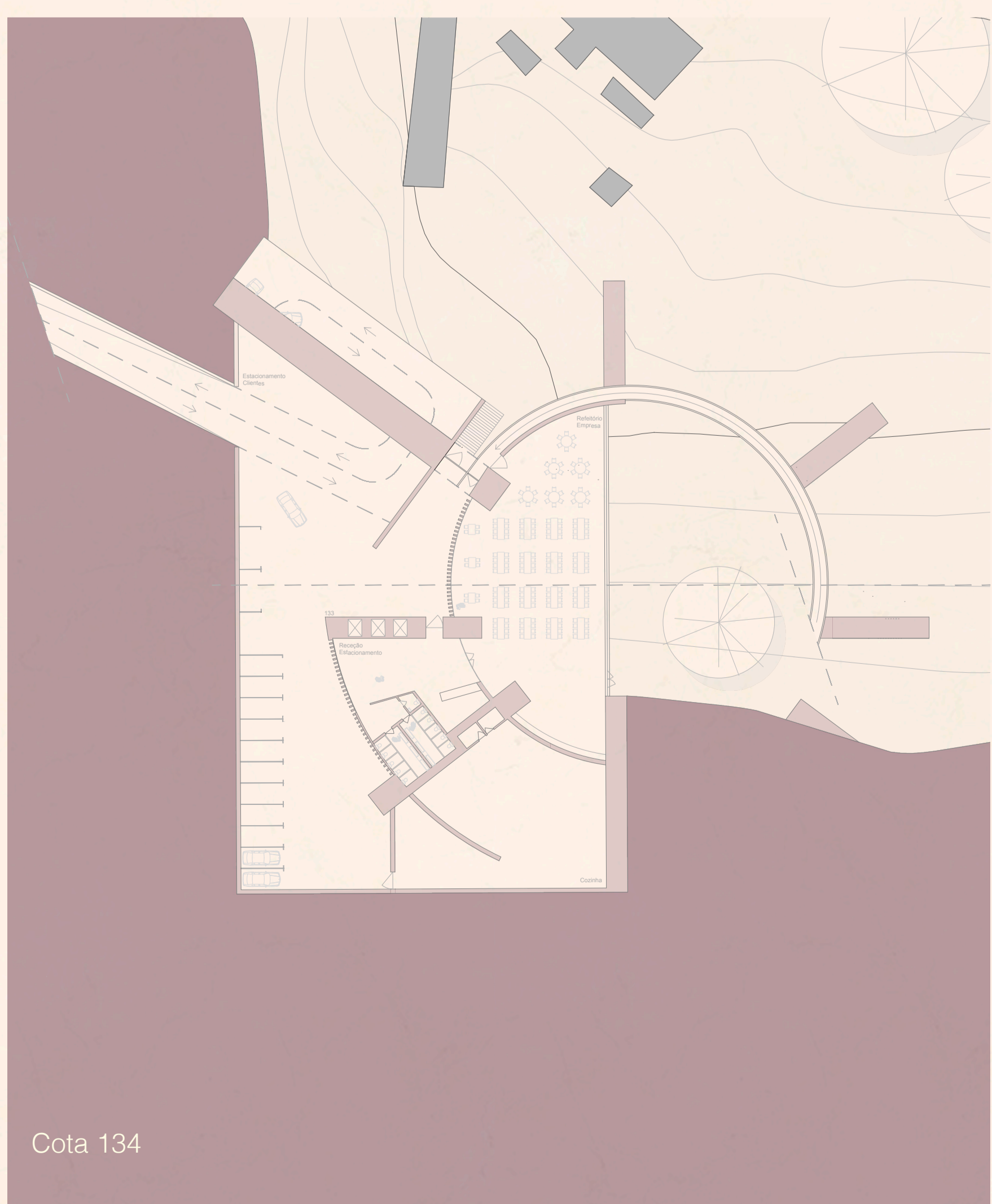
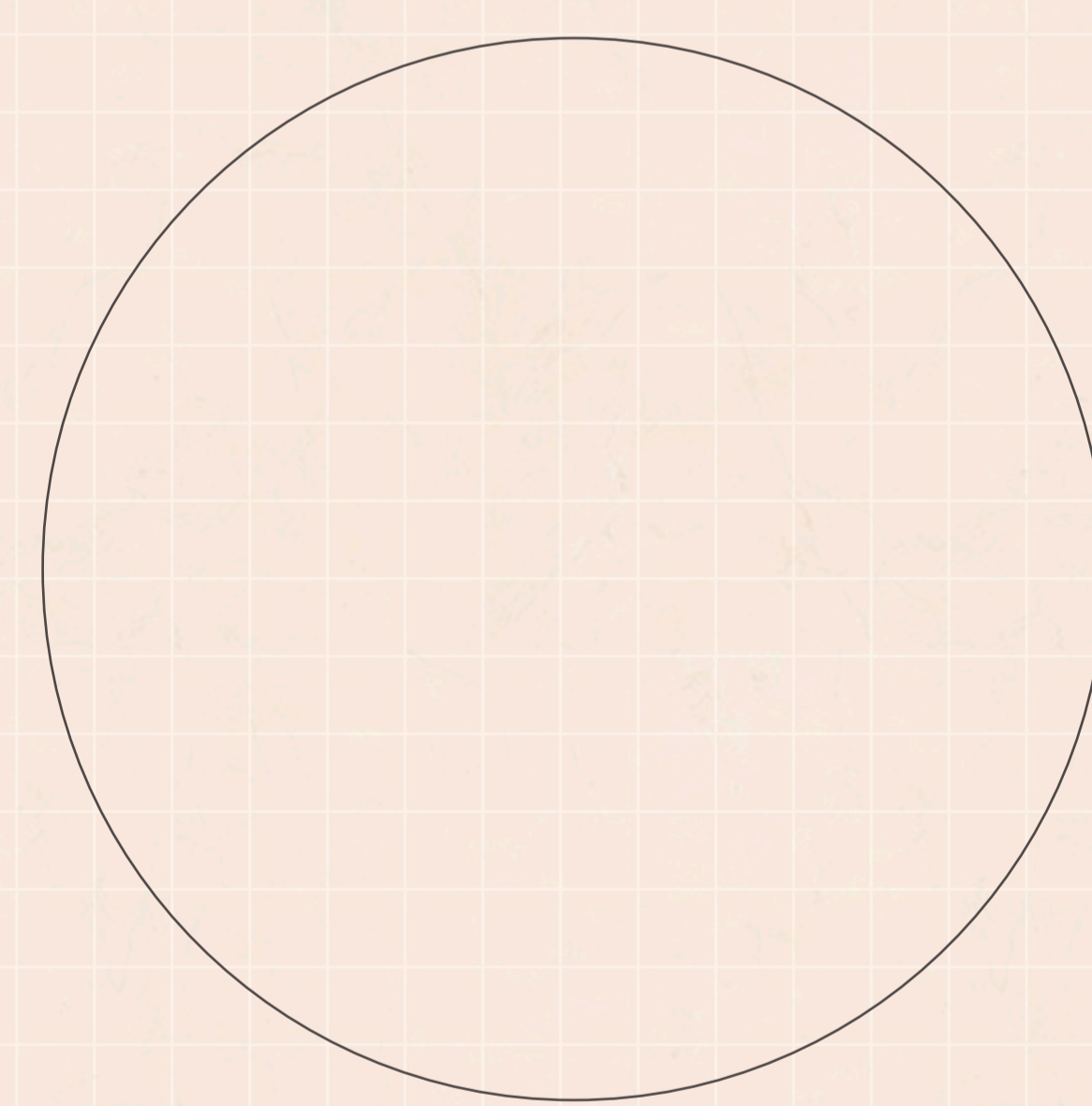
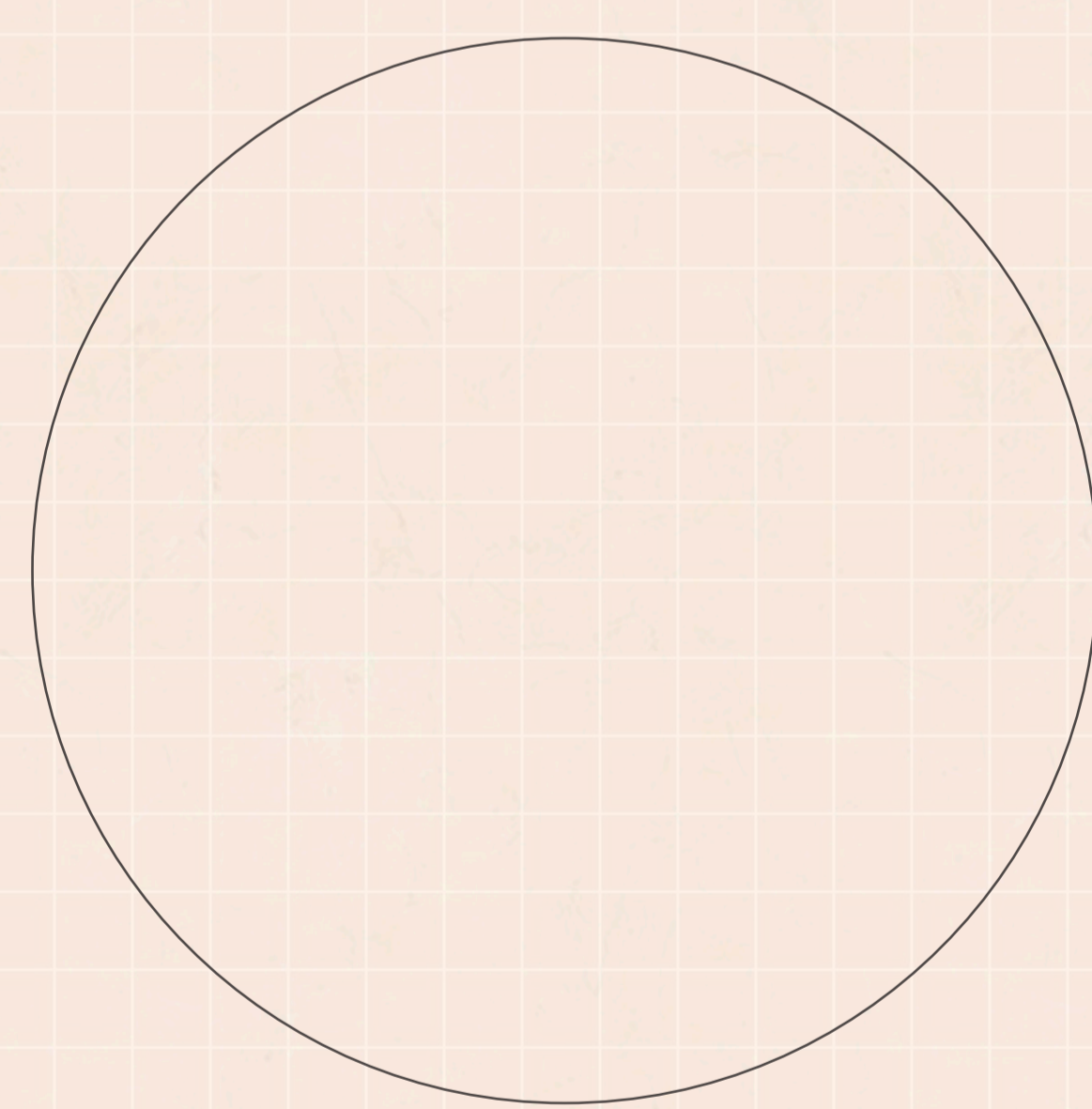
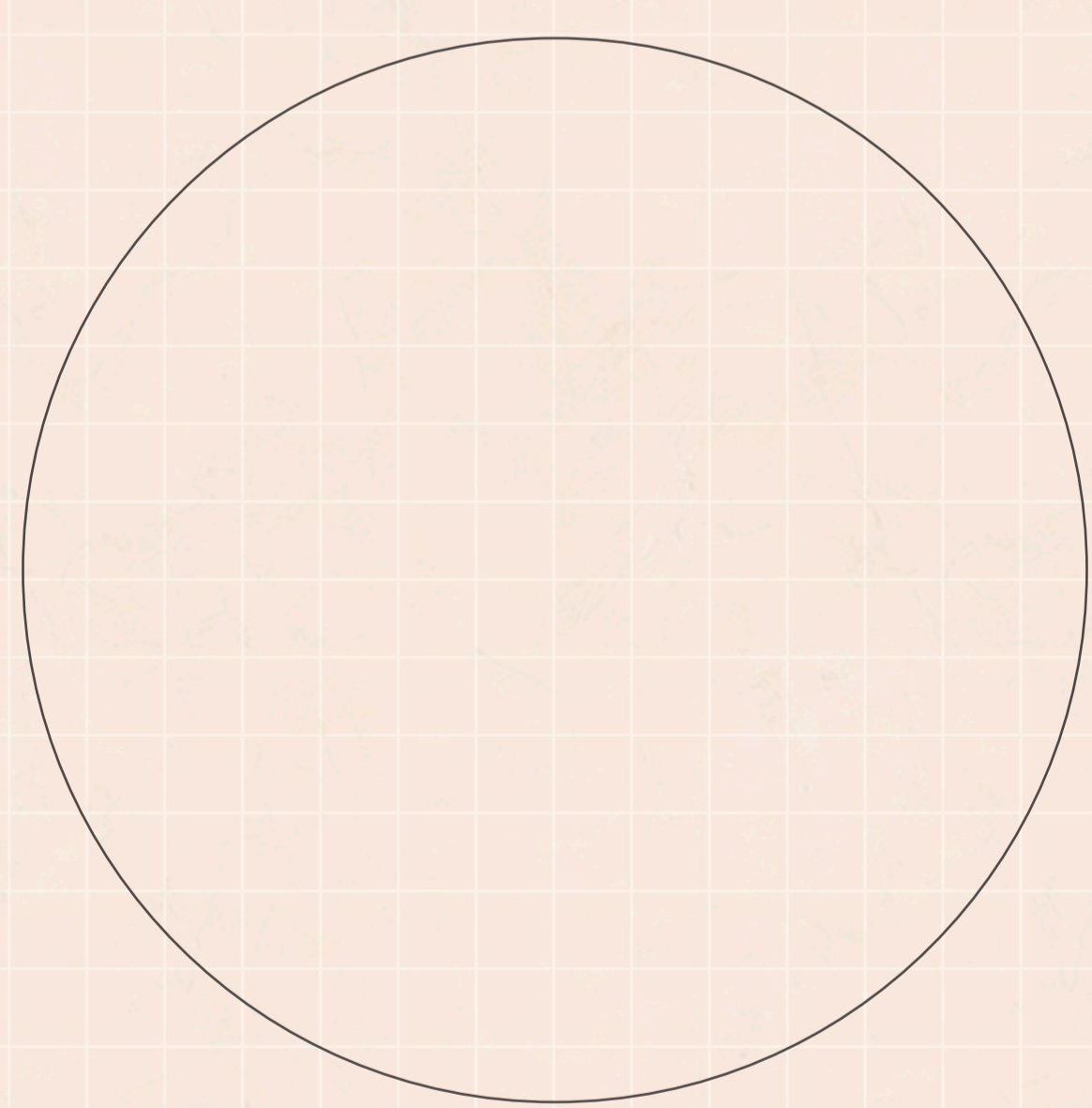
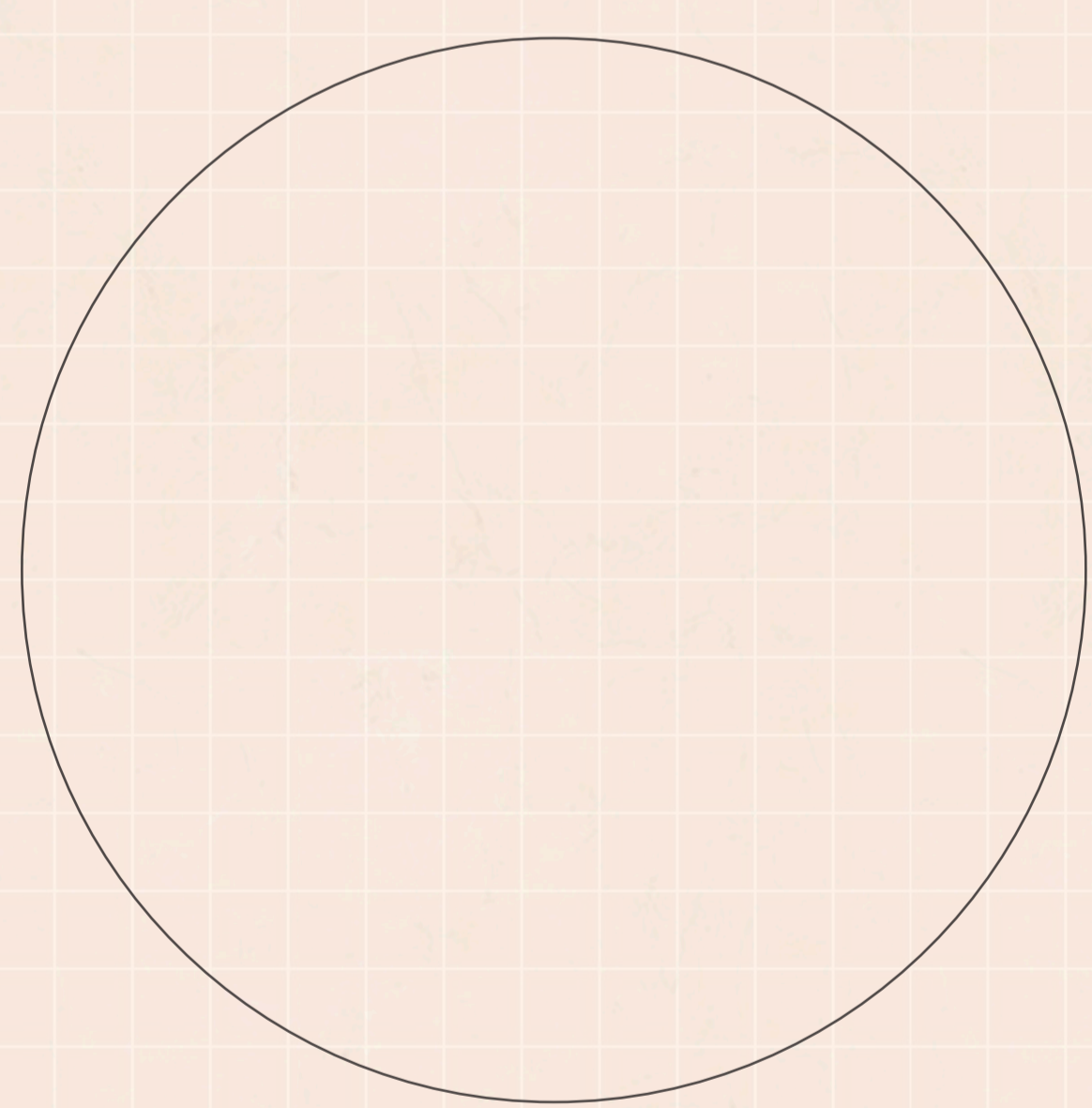
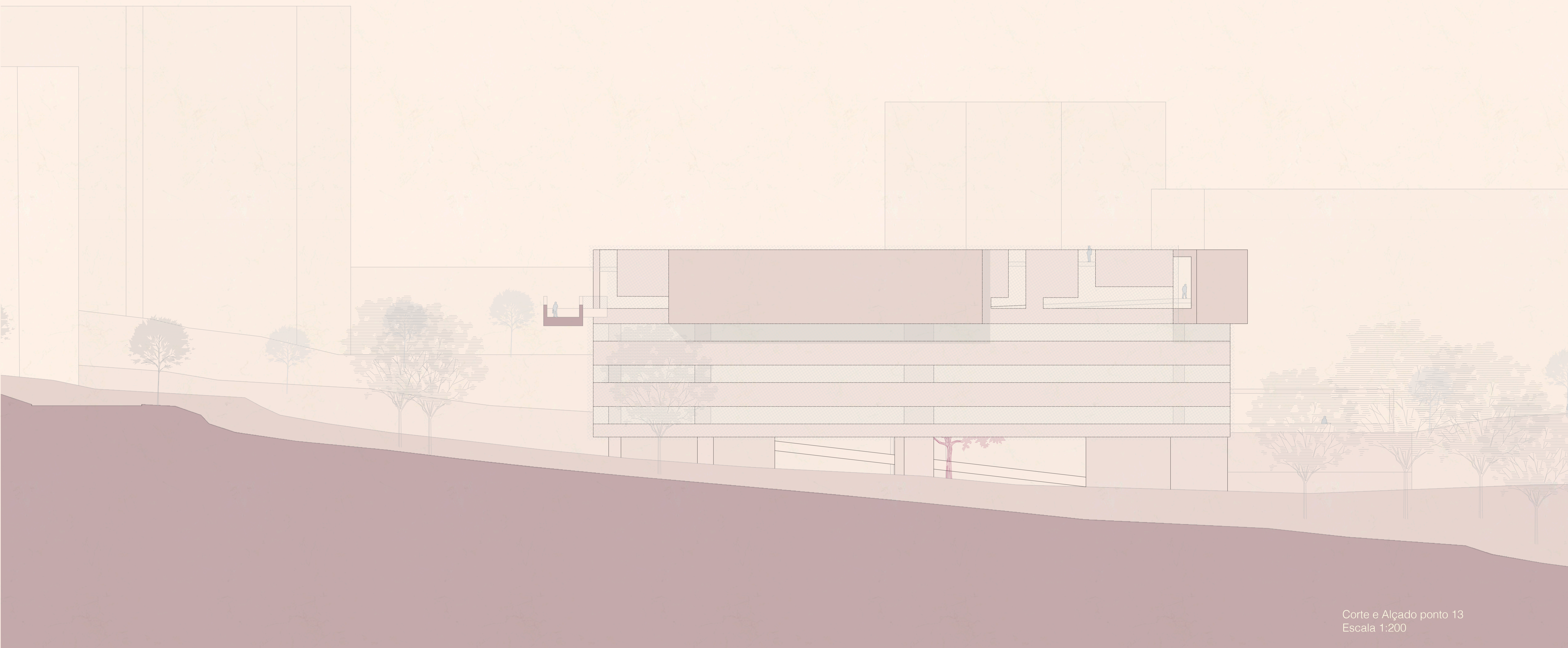
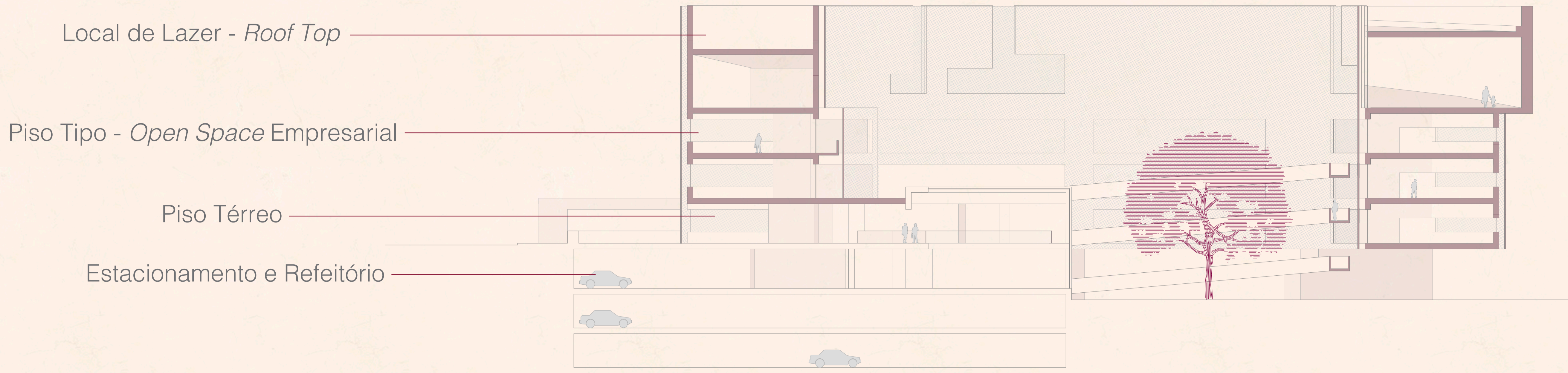
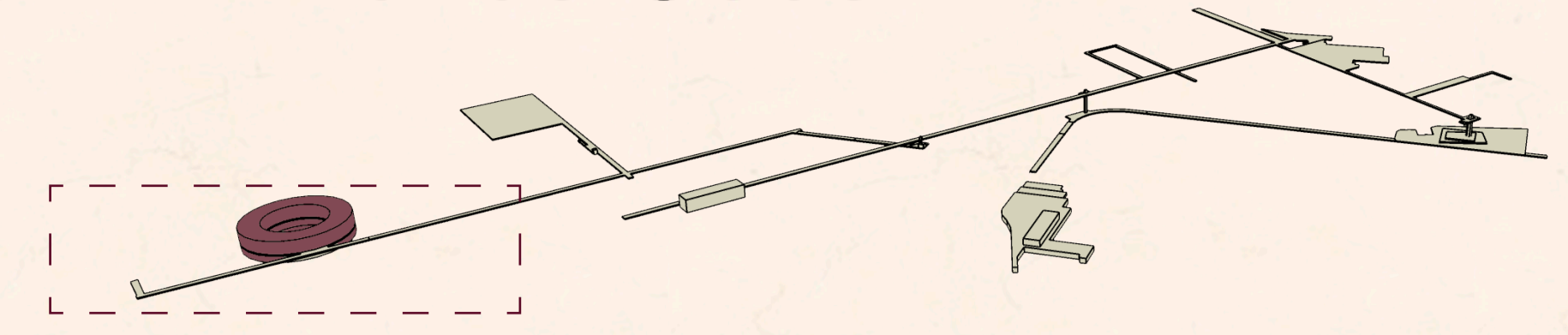



Corte ponto 13
Escala 1:50

